



PolyRail®

VINYL RAILING

TRX & T-Bird



**Digger
Specialties
Inc.**

Transforming the Outdoor Living Experience®

DYNAMIC SOLUTIONS INNOVATION

Since 1984 Digger Specialties, Inc. (DSI) has been manufacturing quality products for the outdoor living industry.

At DSI we are continually working to provide solutions through innovative product development and design to bring the best products to our customers, the marketplace, and the home owner.

Our PolyRail® TRX and T-Bird Vinyl Railing offer a variety of colors, baluster options, and posts to enhance your outdoor living space. This premium line of railing provides a great investment in your home, and is backed by a Lifetime Limited Warranty.



**Digger
Specialties
Inc.**

Transforming the Outdoor Living Experience®



TABLE OF CONTENTS

Features	2
Product Details	3
Vinyl and Aluminum Colors	4
Powder Coating Process	5
TRX Models	6-7
T-Bird Models	8-9
Gates & Hardware	10
ADA Continuous Handrail	11
Rail Mounts & Accessories	12
Post Mounts	13
Vinyl Posts & Post Wraps	14-15
"B" Series Deco Aluminum Posts	16
Post Accessories	17

FEATURES



Lifetime Limited Warranty

Digger Specialties, Inc. is proud to offer one of the strongest warranties in the industry. Our Vinyl Transferable Lifetime Limited Warranty and our Aluminum Lifetime Limited Warranty demonstrates our faith in our product and our commitment to you.



Click QR Code to view and register a DSI warranty or visit the DSI website.



Committed to the Environment and our Community

DSI is proud to be an environmentally aware company that continues to update practices to reduce our carbon foot-print. DSI consistently recycles cardboard, wood, steel banding, zinc die cast, and heat shrink scrap. DSI also utilizes both aluminum and vinyl extrusions that contain recycled content. DSI is pleased to support our community by outsourcing a portion of our packaging functions to a local company that provides meaningful employment to individuals with disabilities.

1

Fast Assembly

Boxed Kits include everything needed for a fast section assembly.



2

Wide Choice of Designs

A variety of baluster options gives homeowners the ability to create the perfect design for their outdoor living area.



3

No Unsightly Screws

Top and bottom rail mounts are designed to hide screws. Eliminating visible screws offers a streamlined look.



4

Lasting Strength and Durability

Top and bottom rails are aluminum reinforced for added strength and durability.





PRODUCT DETAILS

	TRX	T-Bird
Heights	36", 42"	36", 42"
Straight Section Lengths	Boxed Kits: 4', 5', 6', 7', 8', 9', 10' Crossover Kits: 10', 12', 14', 16' Single Chippendale 4', 5', 6', 7', 8', 9', 10' Double Chippendale 8', 9', 10' Single Caribbean* 4', 5', 6', 7', 8', 9', 10' Double Caribbean* 8', 9', 10'	Boxed Kits: 4', 5', 6', 7', 8', 9', 10' Crossover Kits: 10', 12', 14', 16' Single Chippendale 4', 5', 6', 7', 8', 9', 10' Double Chippendale 7', 8', 9', 10'
Stair Section Lengths	4', 5', 6', 7', 8', 9', 10'	4', 5', 6', 7', 8', 9', 10'
Top Rail	3-1/4"W x 1-3/4"H (.090") T-Rail	3"W x 3-1/2"H (.120") T-Rail
Bottom Rail	1-3/4"W x 1-3/4"H (.080")	1-3/4"W x 3-1/2"H (.110")
Aluminum Reinforcement	Top and Bottom Rails	Top and Bottom Rails
Standard Baluster	1-3/8" x 1-3/8" (.070") Square Vinyl with 3-7/8" Spacing	1-3/8" x 1-3/8" (.070") Square Vinyl with 3-1/2" Spacing
"A" Series Baluster	1-3/8" x 1-3/8" Decorative Vinyl with 3-7/8" Spacing 42" Balusters are Aluminum Reinforced	1-3/8" x 1-3/8" Decorative Vinyl with 3-1/2" Spacing 42" Balusters are Aluminum Reinforced
"B" Series Baluster	3/4" (.050") Round Aluminum with 3-7/8" Spacing Available in any DSI Aluminum Color (Shown on Page 4)	3/4" (.050") Round Aluminum with 3-7/8" Spacing Available in any DSI Aluminum Color (Shown on Page 4)

TRX Rails

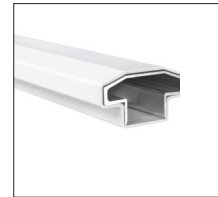

Top Rail with Aluminum Reinforcement



Bottom Rail with Aluminum Reinforcement

T-Bird Rails



Top Rail with Aluminum Reinforcement



Bottom Rail with Aluminum Reinforcement

*Not available in 42"H.

For code compliance information visit diggerspecialties.com/resources/technical-resources/

VINYL COLORS

PolyRail Railing is available in multiple vinyl colors. Some colors are unique to select models. Please see model pages for color availability.

Colors shown are a close approximation of the true color. Please request actual samples for accurate colors.



White



Tan



Mocha

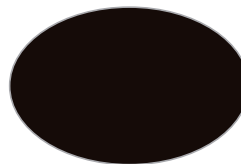

Black Onyx

ALUMINUM COLORS



DSI Aluminum Products are offered in 12 standard AAMA 2604 colors, including satin and textured colors, to complement your project. Custom colors and AAMA 2605 colors are available by special order.

Colors shown are a close approximation of the true color. Please request actual samples for accurate colors.

Textured Colors



White Fine Texture

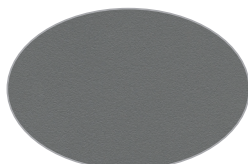

Grey Fine Texture



Bronze Fine Texture



Brown Fine Texture



Black Fine Texture

Non Textured Colors



Gloss White



Gloss Beige



Sandy Shore



Ninety Bronze



Speckled Walnut



Chocolate

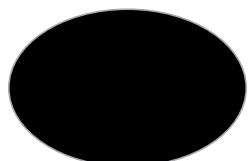

Satin Black



POWDER COATING PROCESS

Exclusive DSI Powder Coating Process

DSI is an industry leader in Powder Coated Aluminum Products. State-of-the-art technology is used to provide a high-quality and durable finish that is more resistant to the effects of impacts, chemicals, ultra-violet light, moisture, and extreme weather conditions.

The process begins with a system certified by the Powder Coating Institute (PCI) and continues with the American Architectural Manufacturers Association (AAMA) / Fenestration and Glazing Industry Alliance (FGIA) verifying our Powder Coating. These stringent processes provide homeowners with peace of mind in their investment.

Our Aluminum Lifetime Limited Warranty includes a Fade Warranty as well as a Salt and Abrasive Environments Warranty providing one of the best warranties in the industry.



1
The raw premium-grade aluminum is inspected to be free of blemishes and is not exposed to the outdoor elements.

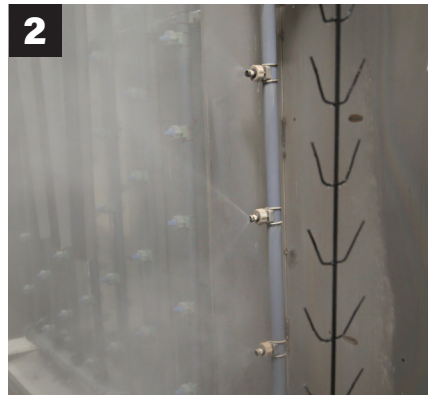

2
The product enters a heated cleaning stage to remove extrusion debris and fabrication oils.



3-6
Clean: City water rinse
Cleaner: Recycling reverse osmosis water rinse
Cleanest: Pure reverse osmosis water rinse
Sealer: Dried-in-place aluminum sealer

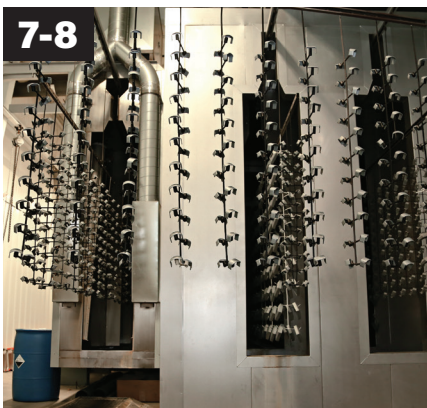

7-8
A 200 MPH air blast removes water drops from the pre-treated aluminum.
A convection oven completes the dry-off process.

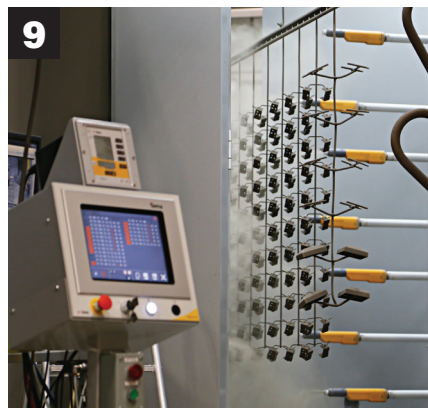

9
Powder is applied with 18 automated and 2 manual spray guns. Compressed process air is dried to -35°F Dew Point for superior adhesion.

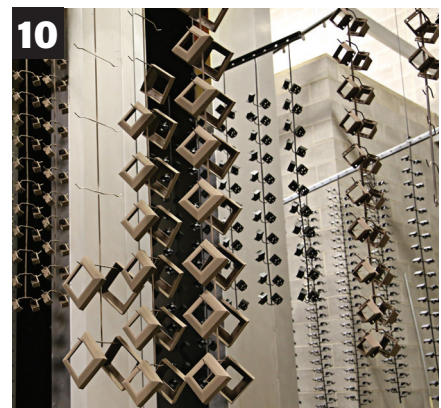

10
The powder coating is then bonded and adhered to the aluminum substrate in a 400 degree cure stage.



TRX

MODELS





TRX Vinyl Railing enhances outdoor spaces with its distinctive contoured T-top rail design, bringing both style and strength to any deck. Engineered for lasting durability, its top and bottom rails are reinforced with aluminum, ensuring superior stability and performance. Best of all, TRX is virtually maintenance-free, so homeowners can enjoy their outdoor space without the hassle of constant upkeep.

BOXED KITS

Section Kits Include: Rails, Balusters, Mounts (4), and Installation Instructions. One Railing Support is also included with all 5' - 10' Straight Sections.



Standard Baluster
36", 42"

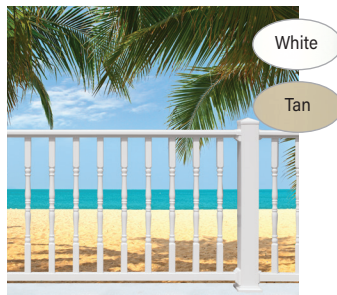

"A" Series Baluster
36", 42"

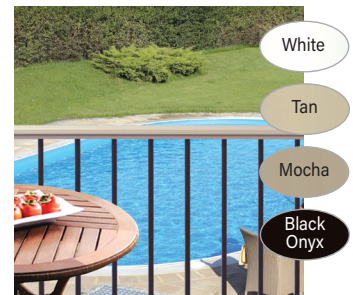

"B" Series Baluster
36", 42"

CROSSOVER KITS

Crossover Section Kits Include: Rails, Balusters, Crossover Post Kit, Mounts (6), and Installation Instructions. Two Railing Supports are included with all Sections.

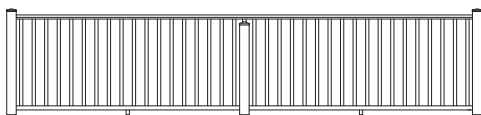

Standard, "A" Series, or "B" Series Balusters
36", 42"

ASSEMBLED CHIPPENDALE

Chippendale Sections Include: Assembled Section, Mounts (4), and Installation Instructions. One Railing Support is included with all 5' - 10' Sections.

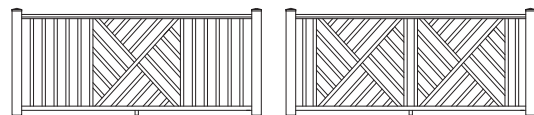

Single
36", 42"

Double
36", 42"

ASSEMBLED CARIBBEAN

Caribbean Sections Include: Assembled Section, Mounts (4), and Installation Instructions. One Railing Support is included with all 5' - 10' Sections.

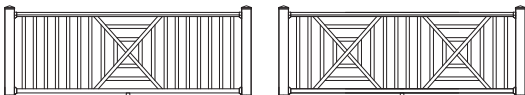

Single
36"

Double
36"

BLACK ONYX "B" SERIES



Click QR Code for additional information.

Available with Satin Black or Black Fine Texture Balusters



T-BIRD

MODELS





T-Bird Vinyl Railing features a distinctive T-shaped top rail that enhances both aesthetics and functionality. Designed with convenience in mind, this unique profile doubles as a built-in drink rail, providing the perfect spot for beverages while entertaining or unwinding outdoors. With its stylish design and practical appeal, T-Bird Vinyl Railing brings both comfort and sophistication to any outdoor living space.

BOXED KITS

Section Kits Include: Rails, Balusters, Mounts (4), and Installation Instructions. One Railing Support is also included with all 8' - 10' Straight Sections.



Standard Baluster
36", 42"



"A" Series Baluster
36", 42"



"B" Series Baluster
36", 42"

CROSSOVER KITS

Crossover Section Kits Include: Rails, Balusters, Crossover Post Kit, Mounts (6), and Installation Instructions.

Two Railing Supports are included with 16' Sections.

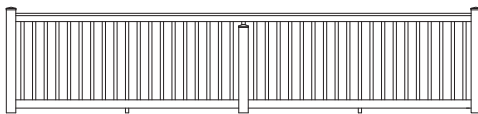

Standard, "A" Series, or "B" Series Balusters
36", 42"

ASSEMBLED CHIPPENDALE

Chippendale Sections Include: Assembled Section, Mounts (4), and Installation Instructions.

One Railing Support is included with all 8' - 10' Sections.

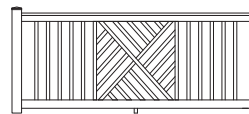

Single
36", 42"

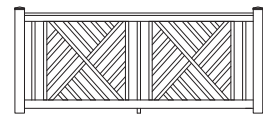

Double
36", 42"

GATES & HARDWARE

Each of our PolyRail Railing models have optional matching gates. All gates include an aluminum reinforced frame for added strength and durability.

Gates

Standard Single Gate Opening Sizes: 36", 48"

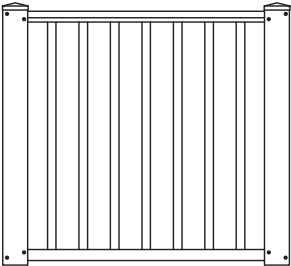

TRX

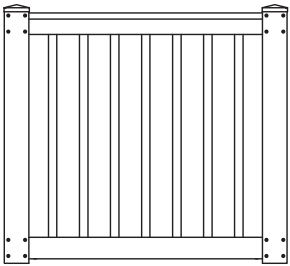

T-Bird

Hardware

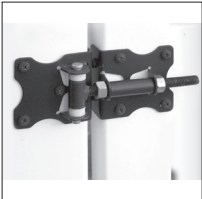

Residential Hinge

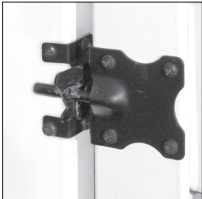

Residential Latch



Mocha is available for **select** products. Please see individual product pages for availability.



Custom gate sizes are available. Contact Customer Service for more information.

ADA

CONTINUOUS HANDRAIL



ADA Continuous Handrail is designed to assist individuals with accessibility and mobility concerns.

This system offers versatile components and accessories, providing the perfect safety solution for stairways, ramps, and decks.

ADA Continuous Handrail is easy to install on any surface and is compatible with new or existing railing systems.

Available in DSI's 12 Standard Aluminum colors as well as custom colors.

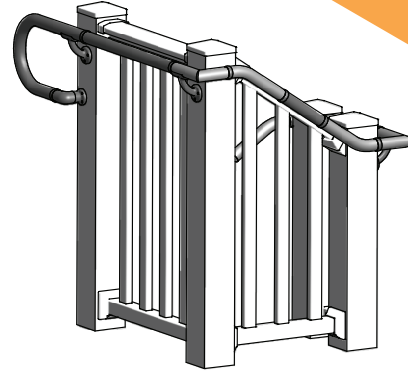

Installation Examples

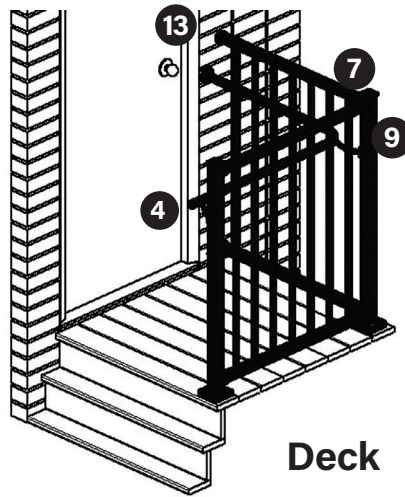
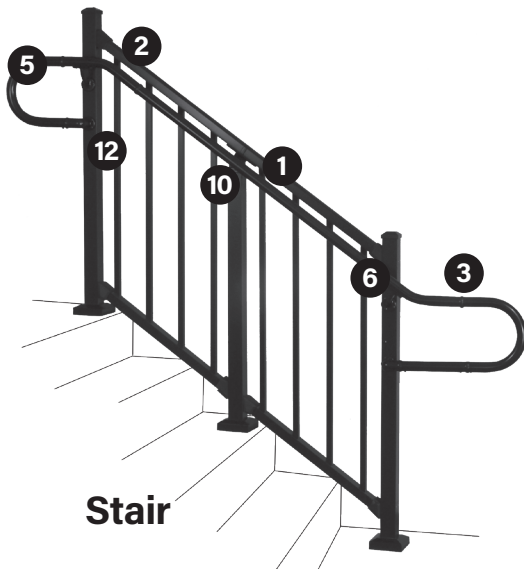

Inside Corner Mount & 90° Elbow Detail



Extended Wall Mount Detail



90° Welded Elbow Detail

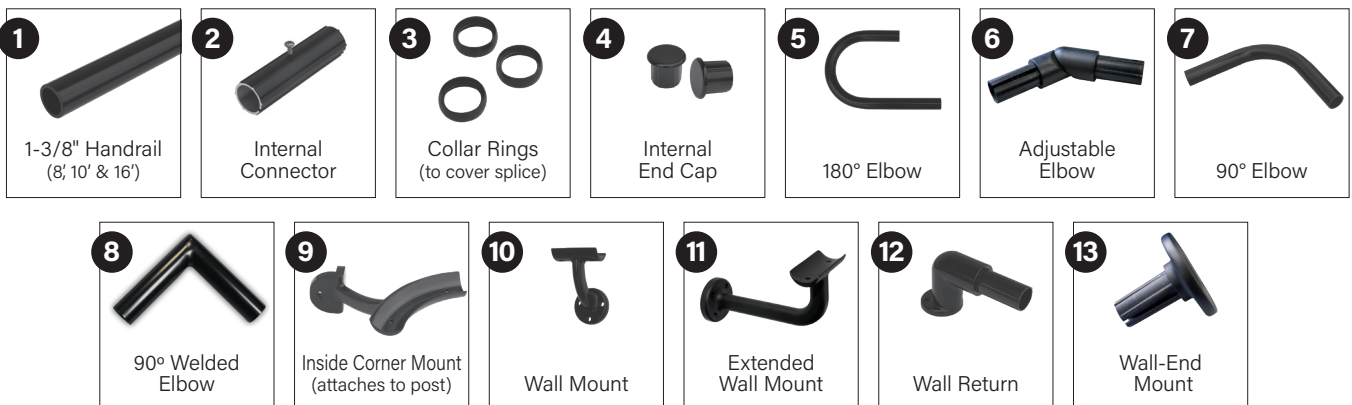

RAIL MOUNTS & ACCESSORIES

Standard Wall Mounts

One 4 pack is included with each railing section.

A 4 pack contains:

- (2) Top Mounts
- (2) Bottom Mounts
- Screws

TRX



Top Rail Mount



Bottom Rail Mount

T-Bird

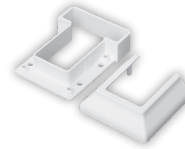

Top Rail Mount



Bottom Rail Mount

Standard Stair Mounts

One 4 pack is included with each railing section.

A 4 pack contains:

- (2) Top Mounts
- (2) Bottom Mounts
- Screws



Top Stair Mount
(factory pre-cut)



Bottom Stair/
Angle Mount

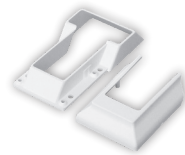

Top Stair Mount

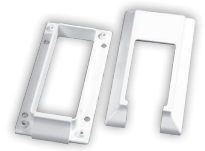

Bottom Stair Mount

Specialty Mounts

These mounts are not included with boxed sections.

A 4 pack contains:

- (2) Top Mounts
- (2) Bottom Mounts
- Screws



Top Stair/
Angle Mount (uncut)



Bottom Stair/
Angle Mount



Top/Bottom
Angle Mount



Top 45° Mount
(factory pre-cut)



Bottom 45° Mount
(factory pre-cut)



Top 45° Mount
(factory pre-cut)



Bottom 45° Mount
(factory pre-cut)



Click QR Code for PolyRail Stair Racking Guides

8" and 10" Round Smooth Column Adapters



Level Rail Stair Rail

Not Available in 6"

6" and 8" Round Fluted Column Adapters



Level Rail

Stair Rail

Not Available in 10"

Rail Supports



Standard Vinyl

"B" Series Aluminum

POST MOUNTS



Top and Bottom Mounts for Vinyl Posts

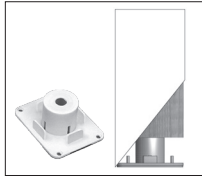

4" Top & Bottom Post Mount Plates

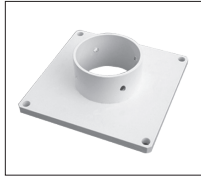

5" Top & Bottom Hurricane Mount Set (for 5" Square Support Posts)

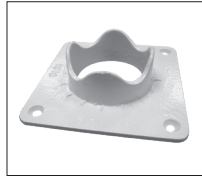

5" Top & Bottom Post Mount Plate Set (for 5" Decorative Support Posts)

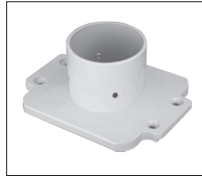

Optional 5" Top & Bottom Hurricane Mount Sets are Tested for High Wind Loads (for 5" "A" Series Post)



Top Mount (Plastic Wood) 4", 5", 6"

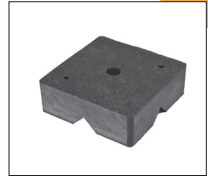

Bottom Mount (Plastic Wood) 4", 5", 6"

4" Residential Adjustable Aluminum Post Mounts

Requires 4" (.160" Wall) Post Sleeve



Heavy Duty

Standard

Powder coated base plates resist corrosion and ACQ wood treatment.

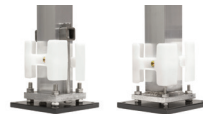

Angle Adjustment Leveling Bolts

TRX Boxed Post Kit

5 Options Available:

1. Without Aluminum Post Mount
2. With IRC Post Mount
3. With IBC Post Mount
4. With Residential Heavy Duty Post Mount
5. With Residential Standard Post Mount

Includes:

- 4" x 4" Vinyl Post
- Post Mount (optional)
- Flat or Trim Cap
- Post Flair

IBC and IRC Post Mounts



Requires 4" (.135" Wall) Post Sleeve



Requires 4" (.135" Wall) Post Sleeve



	4" IBC (Heavy Duty) Post Mount	4" IRC (Standard) Post Mount	4" IRC "A" Series (Standard) Post Mount	5" IRC (Standard) Post Mount	6" IRC (Standard) Post Mount
Heights	37", 43", 47", 53"	37", 43", 47", 53"	37", 43", 47", 53"	37", 47"	37", 47"

VINYL POSTS & POST WRAPS

Standard Vinyl Posts



	4" Square Post Sleeve (.160" Wall)	4" Square Post Sleeve (.135" Wall)	5" Square Post Sleeve	5" Square Support Post	6" Square Post Sleeve
Heights	38", 44", 48"	38", 44", 48", 54" 8', 9', 10'	38", 44", 48", 54" 8', 9', 10'	8', 9', 10'	38", 44", 48", 54" 10'
Load Capacity	Non-Load Bearing w/o Wood Post	Non-Load Bearing w/o Wood Post	Non-Load Bearing w/o Wood Post	8' - 12,000 lb.	Non-Load Bearing w/o Wood Post
Compatible Flair	4" Snap Lock Flair (1-piece)	4" Flair (1-piece) 4" Flair (2-piece)	5" Flair (1-piece)	5" Flair (1-piece)	6" Decorative Flair (1-piece)
Compatible Top and Bottom Post Mounts	N/A	4" Top and Bottom Post Mount Plate 4" Top Mount and 4" Bottom Mount (Plastic Wood)	5" Top Mount and 5" Bottom Mount (Plastic Wood)	5" Top and Bottom Hurricane Mount Set (Included)	6" Top Mount and 6" Bottom Mount (Plastic Wood)



Column Clad Vinyl Post Wraps

The Wood Post Supplies Load Capacity

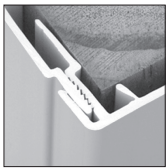

Ratchets to Lock Together



Wraps Around the Wood Post – No Screws Needed



"A" Series Decorative Vinyl Posts



	4" Smooth Column Clad	6" Smooth Column Clad	4" "A" Series Post Sleeve	4" "A" Series Support Post	5" "A" Series Support Post	5" Victorian Support Post
Heights	8', 10'	8', 10'	38", 44", 48", 52"	9'	9', 10'	9'
Load Capacity	Non-Load Bearing w/o Wood Post	Non-Load Bearing w/o Wood Post	Non-Load Bearing w/o Aluminum Post Mount	3,900 lb.	9' = 7,520 lb.	7,520 lb.
Compatible Flair	4" Column Clad Flair (4-piece)	6" Column Clad Flair (4-piece)	4" Flair (1-piece) 4" Flair (2-piece) 4" Snap Lock Flair (1-piece)	4" Flair (1-piece) 4" Flair (2-piece) 4" Snap Lock Flair (1-piece)	5" Decorative Flair (4-piece)	5" Decorative Flair (4-piece)
Compatible Top and Bottom Post Mounts	N/A	N/A	N/A	4" Top and Bottom Post Mount Plate (Included)	5" Top and Bottom Post Mount Plate (Included) 5" Top and Bottom Hurricane Mount Set (Optional)	5" Top and Bottom Post Mount Plate (Included) 5" Top and Bottom Hurricane Mount Set (Optional)

"B" SERIES DECO ALUMINUM POSTS

Available in DSI's 12 Standard Aluminum colors as well as custom colors.



	4" "B" Series Deco Post Sleeve (.065" Wall)	4" "B" Series Deco Post w/Plate (.090" Wall)	6" "B" Series Deco Post w/Plate (.110" Wall)	4" "B" Series Deco Support Post (.090" Wall)	6" "B" Series Deco Support Post (.110" Wall)
Heights	38", 44", 48", 54"	38", 44", 48", 54"	38", 44", 48", 54"	8', 9', 10'	8', 9', 10'
ASD Capacity* (Allowable Axial Loads)	Non-Load Bearing w/o Wood Post	Non-Load Bearing	Non-Load Bearing	8' = 13,531 lb. 9' = 12,751 lb. 10' = 11,970 lb.	8' = 16,543 lb. 9' = 16,543 lb. 10' = 16,543 lb.

*Weight values are Actual Calculated Allowable Loads

POST ACCESSORIES



Vinyl Post Caps

White Tan Mocha

Mocha is available for **select** products. Please see individual product pages for availability.



Flat Cap
4", 5", 6"



Trim Cap
4", 5", 6"



Gothic Cap
4", 5"



Ball Cap
4", 5"



Column Clad Cap
4", 6"



"A" Series Decorative Caps Easily Attach with Vinyl Adhesive (Cap is Included with Post)

Magenta Star® Post Cap Lighting

White Tan Mocha

Mocha is available for **select** products. Please see individual product pages for availability.

Magenta Star® Ornamental Low Voltage Lights. Visit magenastar.com for more information.



Ornamental Low Voltage 4"



Downward Low Voltage 4"



Combo Low Voltage 4"

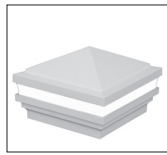

Ornamental Low Voltage 5"



Side Light



Tear Drop Side Light



Riser Light

Vinyl Post Flairs

White Tan Mocha

Mocha is available for **select** products. Please see individual product pages for availability.



4" Flair (1-piece)



4" Flair (2-piece)



4" Snap Lock Flair (1-piece)



5" Flair (1-piece)



5" Decorative Flair (4-piece)



6" Decorative Flair (1-piece)



4", 6" Clad Flair (4-piece)

"B" Series Deco Post Accessories

Available in DSI's 12 Standard Aluminum colors as well as custom colors.

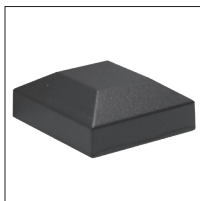

Flat Cap
4", 6"



Ball Cap
4"

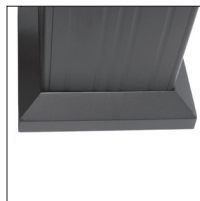

Post Flair (2-piece)
4", 6"



Tie Down Bracket with Cover (Set of 2)

Installation Instructions Require 2 Sets per Support Post.



Transforming the Outdoor Living Experience®

DSI FAMILY OF PRODUCTS



M
Magenta Star®
LIGHTING SYSTEM



W
Westbury®
ALUMINUM RAILING



W
Westbury®
COLUMNS

Stay Connected
diggerspecialties.com



We have tried to make this brochure comprehensive and factual. We reserve the right to discontinue at any time, without notice, colors, materials, equipment, and availability. Since some information may have been updated since the time of printing, we are not responsible for typographical or pictorial errors. Materials shown may vary slightly from actual colors and photos may show optional items. ©Digger Specialties, Inc. 2025/03 99677