

*Poly***RAIL**<sup>®</sup>  
**Systems**  
BY DIGGER SPECIALTIES, INC.

VINYL RAILING



MADE  
IN THE  
USA 

# PolyRAIL<sup>®</sup> Systems

BY DICGER SPECIALTIES, INC.



Whether you want to make your home impressive, comfortable, traditional, or distinctive - PolyRail<sup>®</sup> Vinyl Railing is designed with you in mind. PolyRail<sup>®</sup> Vinyl Railing offers a comfortable feel with a traditional look and features a wide range of styles, colors, and applications to enhance your vision. Just imagine the possibilities; after all, your home is your masterpiece.

## TABLE OF CONTENTS

Colors and Powder Coating .....	1
Cardinal Vinyl Railing .....	2-3
Falcon Vinyl Railing .....	4-5
Raven Vinyl Railing .....	6-7
T-Bird Vinyl Railing .....	8-9
Hidden Screw Rail Mounts .....	10
Gates & Hardware .....	11
Standard Vinyl Posts .....	12
Post Mounts .....	13
“A” Series Decorative Vinyl Posts .....	14
Column Clad Vinyl Post Wraps .....	15
“B” Series Aluminum Posts .....	16
Continuous Handrail .....	17

# COLORS

## VINYL COLORS

DSI Vinyl Products are available in three colors. Our Mocha color is available for **select** products. Please see individual product pages for availability.

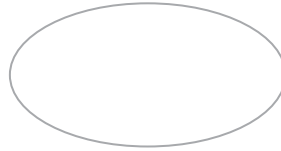

White



Tan



Mocha

## ALUMINUM COLORS

DSI Aluminum Products are offered in 12 standard AAMA 2604 colors. Custom colors and AAMA 2605 colors are available by special order.

Colors shown are a close representation of the true color. Please consult actual samples for accurate powder coating colors.



Satin Black



Black Fine Texture



Ninety Bronze



Bronze Fine Texture



Gloss Beige



Gloss White



White Fine Texture



Brown Fine Texture



Speckled Walnut



Sandy Shore



Chocolate



Silver

## EXCLUSIVE DSI POWDER COATING PROCESS

DSI's aluminum Powder Coating offers an uncompromising quality created by state-of-the-art technology. Our system provides the highest quality powder coating on the market with a lifetime limited warranty giving you peace of mind in your investment.



**1** The raw premium-grade aluminum is inspected to be free of blemishes and is not exposed to the outdoor elements.



**2** The product enters a heated acidic cleaning stage to remove extrusion debris and fabrication oils.



**3-6** **Clean:** City water rinse  
**Cleaner:** Recycling reverse osmosis water rinse  
**Cleanest:** Pure reverse osmosis water rinse  
**Sealer:** Dried-in-place aluminum sealer



**7-8** A 200 MPH air blast removes water drops from the pre-treated aluminum. A convection oven completes the dry-off process.



**9** Powder is applied with 18 automated and 2 manual spray guns. Compressed process air is dried to -35°F Dew Point for superior adhesion.

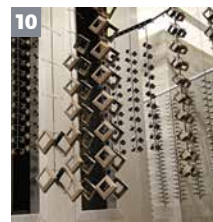

**10** The powder coating is then bonded and adhered to the aluminum substrate in a 400 degree cure stage.



# CARDINAL VINYL RAILING



# CARDINAL RAILING



**STANDARD BALUSTER**  
 7/8" x 1-1/2" Rectangular Vinyl  
 2-7/8" Baluster Spacing

White Tan



**"A" SERIES BALUSTER**  
 7/8" x 1-1/2" Decorative Vinyl  
 2-7/8" Baluster Spacing  
 42" Balusters are Aluminum Reinforced

White Tan



**"B" SERIES BALUSTER**  
 3/4" Round Aluminum  
 3-7/8" Baluster Spacing  
 See Page 1 for Baluster Colors

White Tan

Section Type	Length											Height		Baluster Style		
	4'	5'	6'	7'	8'	9'	10'	12'	14'	16'	36"	42"	Std	A	B	
Straight	•	•	•	•	•	•	•				•	•	•	•	•	
Stair	•	•	•	•	•	•	•				•	•	•	•	•	
Crossover - Straight								•	•	•	•	•	•	•	•	
Crossover - Stair					Not Available						Not Available		Not Available			
Single Chippendale - Straight	•	•	•	•	•	•	•				•	•	•			
Double Chippendale - Straight				•	•	•	•				•	•	•			
Chippendale - Stair					Not Available						Not Available		Not Available			



**CROSSOVER**



**DOUBLE CHIPPENDALE**

Note: Railing Support included with all 8' - 10' sections. 16' Crossover Sections include two Railing Supports.



# FALCON VINYL RAILING



# FALCON RAILING



## STANDARD BALUSTER

1-3/8" x 1-3/8" Square Vinyl  
3-1/2" Baluster Spacing

- White
- Tan
- Mocha



## "A" SERIES BALUSTER

1-3/8" x 1-3/8" Decorative Vinyl  
3-1/2" Baluster Spacing  
42" Balusters are Aluminum Reinforced

- White
- Tan



## "B" SERIES BALUSTER

3/4" Round Aluminum  
3-7/8" Baluster Spacing  
See Page 1 for Baluster Colors

- White
- Tan
- Mocha

Section Type	Length										Height		Baluster Style		
	4'	5'	6'	7'	8'	9'	10'	12'	14'	16'	36"	42"	Std	A	B
Straight	•	•	•	•	•	•	•				•	•	•	•	•
Stair	•	•	•	•	•	•	•				•	•	•	•	•
Crossover - Straight								•	•	•	•	•	•	•	•
Crossover - Stair	Not Available										Not Available		Not Available		
Single Chippendale - Straight	•	•	•	•	•	•	•				•	•	•		
Double Chippendale - Straight				•	•	•	•				•	•	•		
Chippendale - Stair	Not Available										Not Available		Not Available		

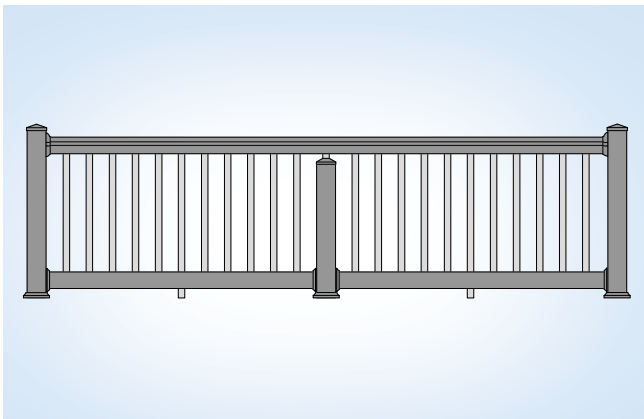

**CROSSOVER**

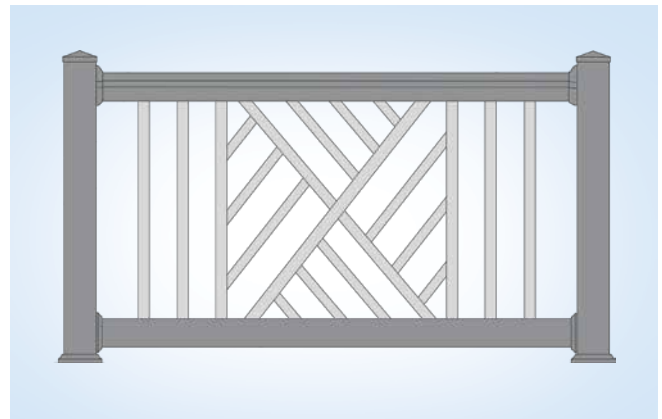

**SINGLE CHIPPENDALE**

Note: Railing Support included with all 8' - 10' sections. 16' Crossover Sections include two Railing Supports.



# RAVEN VINYL RAILING





# RAVEN RAILING



**STANDARD BALUSTER**  
 7/8" x 1-1/2" Rectangular Vinyl  
 2-7/8" Baluster Spacing

White Tan



**"A" SERIES BALUSTER**  
 7/8" x 1-1/2" Decorative Vinyl  
 2-7/8" Baluster Spacing  
 42" Balusters are Aluminum Reinforced

White Tan



**"B" SERIES BALUSTER**  
 3/4" Round Aluminum  
 3-7/8" Baluster Spacing  
 See Page 1 for Baluster Colors

White Tan

Section Type	Length											Height		Baluster Style		
	4'	5'	6'	7'	8'	9'	10'	12'	14'	16'	36"	42"	Std	A	B	
Straight	•	•	•	•	•	•	•				•	•	•	•	•	
Stair	•	•	•	•	•	•	•				•	•	•	•	•	
Crossover - Straight								•	•	•	•	•	•	•	•	
Crossover - Stair	Not Available											Not Available		Not Available		



**CROSSOVER**

Note: Railing Support included with all 7' - 10' sections. 14' and 16' Crossover Sections include two Railing Supports.



# T-BIRD VINYL RAILING



# T-BIRD RAILING



## STANDARD BALUSTER

1-3/8" x 1-3/8" Square Vinyl  
3-1/2" Baluster Spacing



## "A" SERIES BALUSTER

1-3/8" x 1-3/8" Decorative Vinyl  
3-1/2" Baluster Spacing  
42" Balusters are Aluminum Reinforced



## "B" SERIES BALUSTER

3/4" Round Aluminum  
3-7/8" Baluster Spacing  
See Page 1 for Baluster Colors



Section Type	Length										Height		Baluster Style		
	4'	5'	6'	7'	8'	9'	10'	12'	14'	16'	36"	42"	Std	A	B
Straight	•	•	•	•	•	•	•				•	•	•	•	•
Stair	•	•	•	•	•	•	•				•	•	•	•	•
Crossover - Straight								•	•	•	•	•	•	•	•
Crossover - Stair					Not Available						Not Available		Not Available		
Single Chippendale - Straight	•	•	•	•	•	•	•				•	•	•		
Double Chippendale - Straight				•	•	•	•				•	•	•		
Chippendale - Stair					Not Available						Not Available		Not Available		

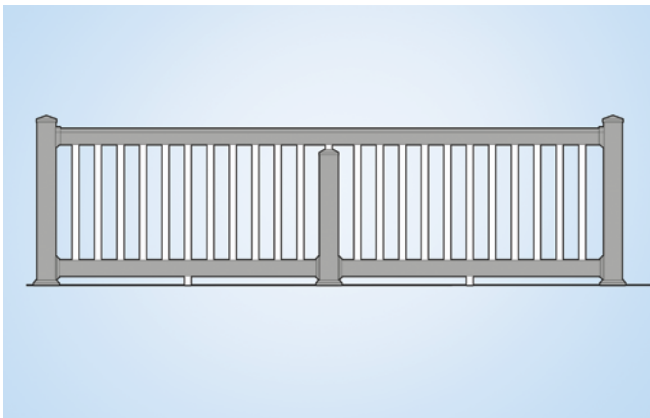

**CROSSOVER**



**DOUBLE CHIPPENDALE**

Note: Railing Support included with all 8' - 10' sections. 16' Crossover Sections include two Railing Supports.

# HIDDEN SCREW RAIL MOUNTS

## STANDARD WALL MOUNTS:

1-4 pack is included inside each boxed railing section.

A 4 pack contains (2) top mounts, (2) bottom mounts, and screws.

### CARDINAL



Top/Bottom Rail Mount

### FALCON



Top Rail Mount

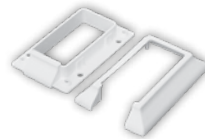

Bottom Rail Mount

### RAVEN



Top Rail Mount



Bottom Rail Mount

### T-BIRD

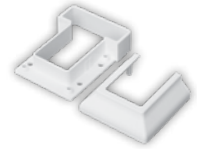

Top Rail Mount



Bottom Rail Mount

## STANDARD STAIR MOUNTS:

1-4 pack is included inside each boxed stair railing section.

A 4 pack contains (2) top mounts, (2) bottom mounts, and screws.

For Stair Racking information visit [polyrail.com](http://polyrail.com)



Top/Bottom Stair Mount



Top Stair Mount



Bottom Stair Mount



Top Stair Mount (factory pre-cut)



Bottom Stair/Angle Mount



Top Stair Mount



Bottom Stair Mount

## OPTIONAL SPECIALTY MOUNTS:

These mounts are not included with boxed sections.

A 4 pack contains (2) top mounts, (2) bottom mounts, and screws.



Top/Bottom Angle Mount



Top/Bottom Angle Mount



Top Stair/Angle Mount (uncut)



Bottom Stair/Angle Mount



Top 45° Mount (factory pre-cut)



Bottom 45° Mount (factory pre-cut)



Top/Bottom Angle Mount



Top 45° Mount



Bottom 45° Mount

## 8" AND 10" ROUND COLUMN ADAPTERS

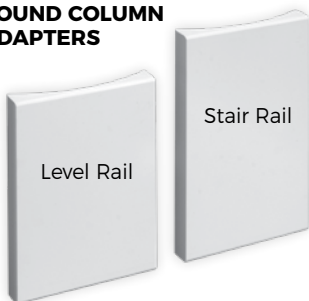

Not Available in 6"

## RAIL SUPPORTS



Standard Vinyl

"B" Series Aluminum

# GATES & HARDWARE

**CARDINAL GATE**



**FALCON GATE**



**RAVEN GATE**

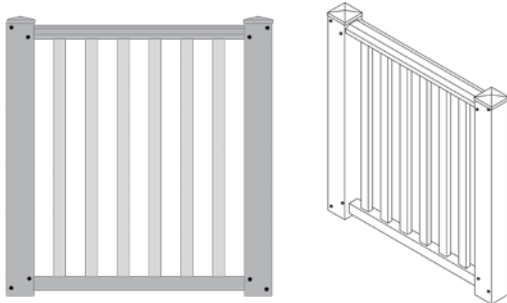

**T-BIRD GATE**



Matching gates available for each style of railing • Aluminum Reinforced Frame  
Available in 36"W and 48"W openings • Special Width Gates Available Upon Request

Baluster Style	Gate Size (width x height)			
	36" x 36"	48" x 36"	36" x 42"	48" x 42"
Standard Baluster	•	•	•	•
"A" Series Baluster	•	•	•	•
"B" Series Baluster	•	•	•	•

**RESIDENTIAL HINGE**

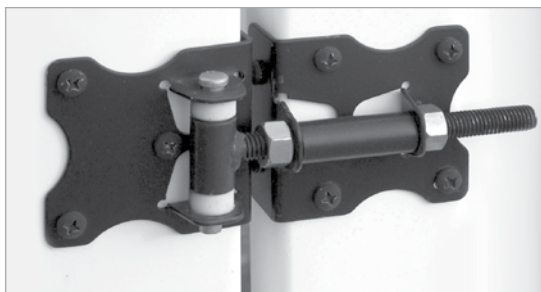

**RESIDENTIAL LATCH**

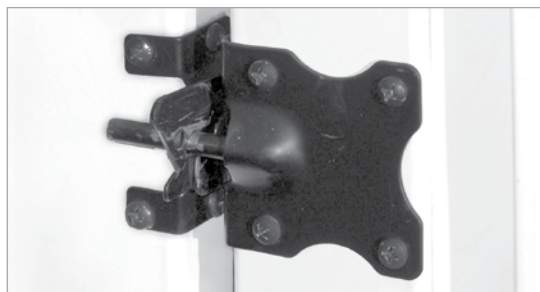

- White
- Tan
- Mocha
- Black

Mocha is available for **select** products. Please see individual product pages for availability.

# STANDARD VINYL POSTS

## VINYL POSTS



## VINYL POST CAPS



## MAGENA STAR

Magenta Star Ornamental Low Voltage and Solar Lights. Visit [magenastar.com](http://magenastar.com) for more information and to see additional styles.

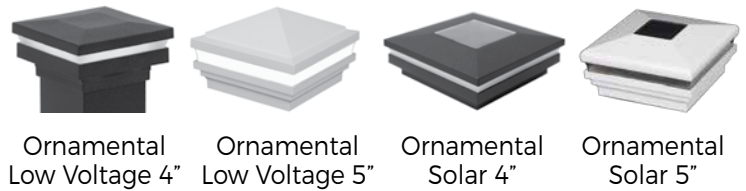

## VINYL POST FLAIRS

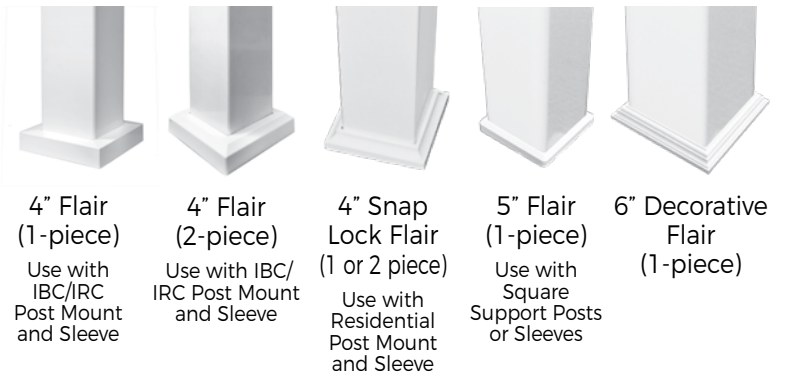

## VINYL POSTS SPECIFICATIONS

	4" Post Sleeve	5" Post Sleeve	5" Support Post	6" Post Sleeve
Heights	38", 44", 48", 54" 8', 9', 10'	38", 44", 48", 54" 8', 9', 10'	8', 9', 10'	38", 44", 48", 54" 10'
Load Capacity	Non-Load Bearing w/o Wood Post	Non-Load Bearing w/o Wood Post	8' = 12,000 lb.	Non-Load Bearing w/o Wood Post

# POST MOUNTS

## 4" RESIDENTIAL ADJUSTABLE ALUMINUM POST MOUNTS

Requires 4" (.160" Wall) Post Sleeve.



Top View

Powder coated base plates resist corrosion and ACQ wood treatment.



Angle Adjustment Leveling Bolts



Heavy-Duty Standard

## TOP AND BOTTOM POST MOUNTS

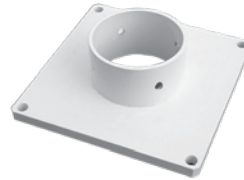

5" Top & Bottom Hurricane Mount Set (Included with all 5" Square Support Posts)

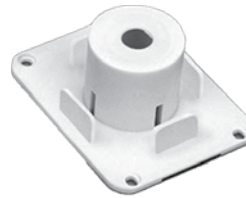

Optional 4" Top and Bottom Post Mount Plates



## 4" IBC AND IRC POST MOUNTS

### IBC (HEAVY DUTY) POST MOUNTS:

- IBC Approved
- 3.62" Tube
- .060" Wall
- ½" x 5½" square plate with 8 fasteners
- Shims and leveling bolts included



Top View

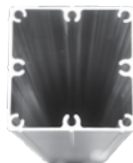

43" IBC Post Mount  
Available in 37", 43", 47" & 53" lengths



37" IRC Post Mount  
Available in 37", 43", 47" & 53" lengths

### IRC (STANDARD) POST MOUNTS:

- IRC Approved
- 3.62" Tube
- .060" Wall
- ¼" x 5½" square plate with 4 fasteners
- Shims and leveling bolts included



Requires 4" (.135" Wall) Post Sleeve  
Note: 5" and 6" Post Mounts available.  
Contact Customer Service for information.

# "A" SERIES DECORATIVE VINYL POSTS

## POSTS

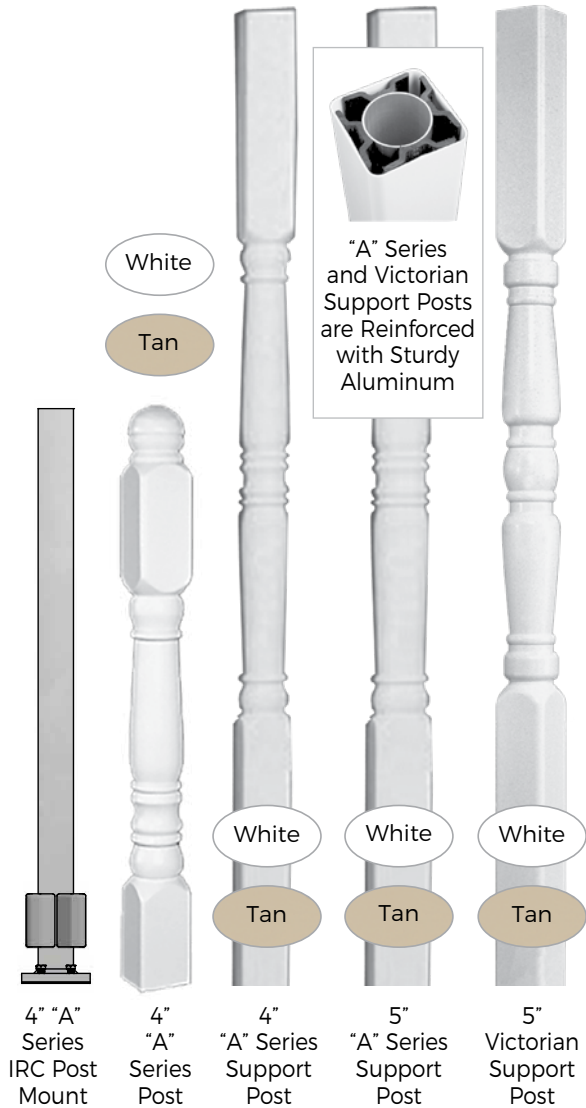

## CAP



"A" Series Decorative Post Caps are Easily Attached with Vinyl Adhesive

Cap is Included with Post

## FLAIRS

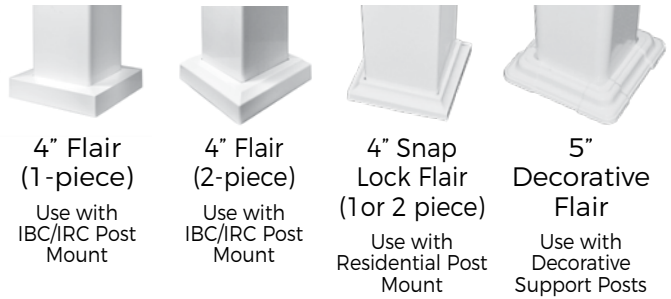

## SUPPORT POST MOUNTS

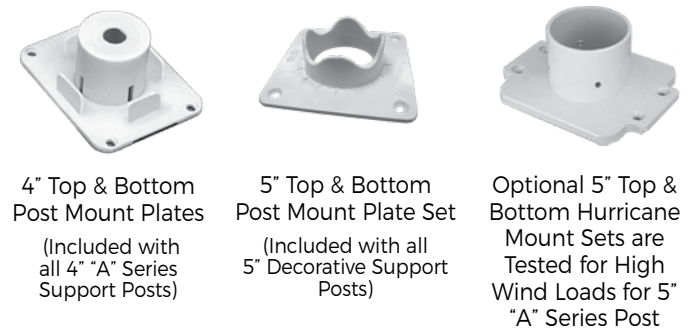

## SPECIFICATIONS

	4" "A" Series Post	4" "A" Series Support Post	5" "A" Series Support Post	5" Victorian Support Post
Heights	38", 44", 48", 52"	9'	9', 10'	9'
Load Capacity	Non-Load Bearing w/o Aluminum Post Mount	3,900 lb.	9' = 7,520 lb.	9' = 7,520 lb.



# COLUMN CLAD VINYL POST WRAPS

## STYLES

The Wood Post Supplies Load Capacity



Ratchets to Lock Together



Wraps Around the Wood Post – No Screws Needed



White  
Tan

Smooth



White  
Tan

Fluted  
(Special Order)

## CAP



Column Clad Cap  
4", 6"

## FLAIR



Column Clad Flair (4-piece)  
4", 6", 8"

## SPECIFICATIONS

	4" Smooth Column Clad	6" Smooth Column Clad	4" Fluted Column Clad	6" Fluted Column Clad	8" Fluted Column Clad
Heights	8'6", 10'	8'6", 10'	8'6", 10' (Special Order)	8'6", 10' (Special Order)	10' (Special Order)
Load Capacity	Non-Load Bearing w/o Wood Post	Non-Load Bearing w/o Wood Post	Non-Load Bearing w/o Wood Post	Non-Load Bearing w/o Wood Post	Non-Load Bearing w/o Wood Post

# "B" SERIES ALUMINUM POSTS

See Page 1 for Color Options

## POSTS



4" Post Sleeve (.065" wall)

4" Post w/Plate (.090" wall)

6" Post w/Plate (.090" wall)

4" Support Post (.090" wall)

6" Support Post (.090" wall)

## CAPS



Flat Cap 4" & 6"

Ball Cap 4"

## FLAIRS



Post Flair (2-piece) 4" & 6"

## TIE DOWN BRACKET



Tie Down Bracket with Cover (Set of 2)

Installation Instructions Require 2 Sets per Support Post

## SPECIFICATIONS

	4" "B" Series Post Sleeve	4" "B" Series Post w/Plate	6" "B" Series Post w/Plate	4" "B" Series Support Post	6" "B" Series Support Post
Heights	38", 44", 48", 54"	38", 44", 48", 54"	38", 44", 48", 54"	8', 9', 10'	8', 9', 10'
Actual ASD Load Bearing Capacity	Non-Load Bearing w/o Wood Post	Non-Load Bearing	Non-Load Bearing	8' = 13,531 lb. 9' = 12,751 lb. 10' = 11,970 lb.	8' = 16,543 lb. 9' = 16,543 lb. 10' = 16,543 lb.

# CHAR

## Continuous Handrail

### ALUMINUM

#### ADA COMPLIANT HANDRAIL

A variety of rail lengths and accessories complete this system.  
 Available in 8', 10', & 16' Rail Lengths.  
 Available in all the colors shown on page 1.

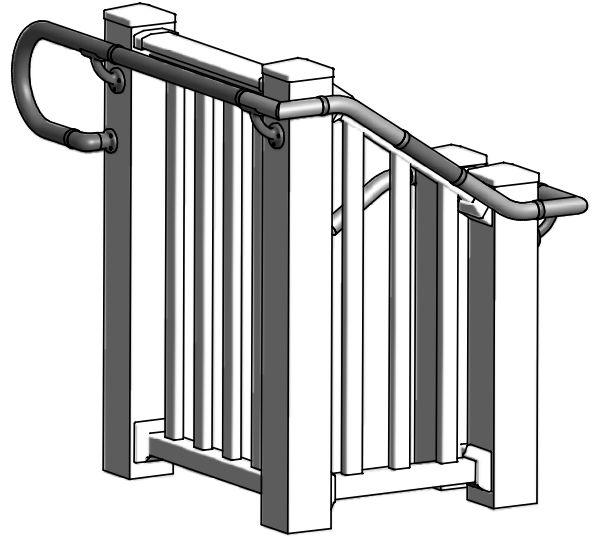

#### STAIR APPLICATION

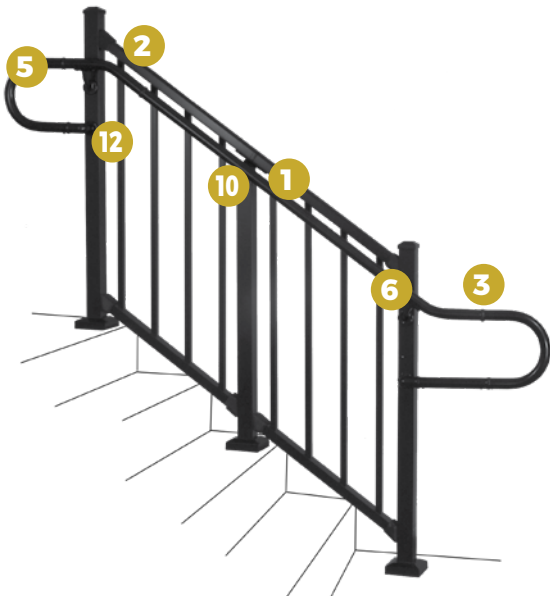

#### DECK APPLICATION

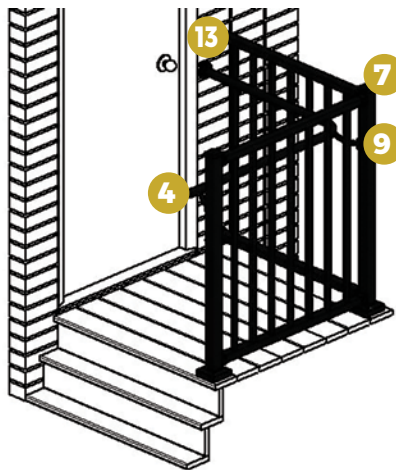













Inside Corner Mount & 90° Elbow Detail



Extended Wall Mount Detail



90° Welded Elbow Detail

 <p><b>1</b> 1-3/8" Handrail (8', 10' &amp; 16')</p>	 <p><b>2</b> Internal Connector</p>	 <p><b>3</b> Collar Rings (to cover splice)</p>	 <p><b>4</b> Internal End Cap</p>	 <p><b>5</b> 180° Elbow</p>	 <p><b>6</b> Adjustable Elbow</p>	 <p><b>7</b> 90° Elbow</p>
 <p><b>8</b> 90° Welded Elbow</p>	 <p><b>9</b> Inside Corner Mount (attaches to post)</p>	 <p><b>10</b> Wall Mount</p>	 <p><b>11</b> Extended Wall Mount</p>	 <p><b>12</b> Wall Return</p>	 <p><b>13</b> Wall-End Mount</p>	

# DSI FAMILY OF PRODUCTS



polyrail.com



We have tried to make this catalog comprehensive and factual. We reserve the right to discontinue at any time, without notice, colors, materials, equipment and availability. Since some information may have been updated since the time of printing, we are not responsible for typographical or pictorial errors. Materials shown may vary slightly from actual colors. ©Digger Specialties 2019/02 99694